

CROC-LOC CONNECTION CLAMPS

To separate units when relocating sofas

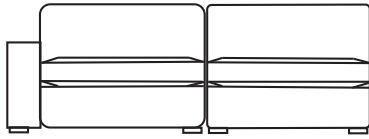

Figure 1. Units closed in normal use

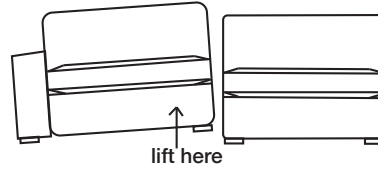

Figure 2. To separate the units, lift the unit with the **triangle stump** in upwards direction (arrow).

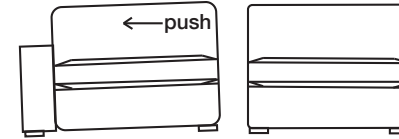

Figure 3. Then push units away from each other.

To attach sofas to stop them from separating

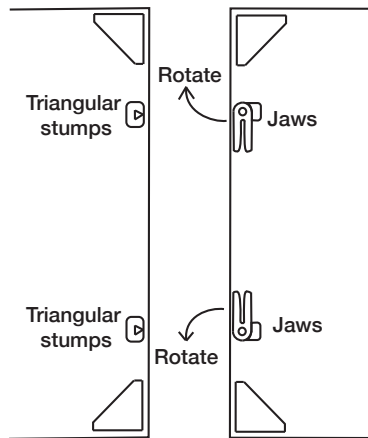

Figure 4. Rotate Croc-loc Jaws 90 degrees, in direction of arrows to position show in Figure 5. (For illustration purposes, views are given from beneath the sofas. The units should always be stood on their feet when assembling.)

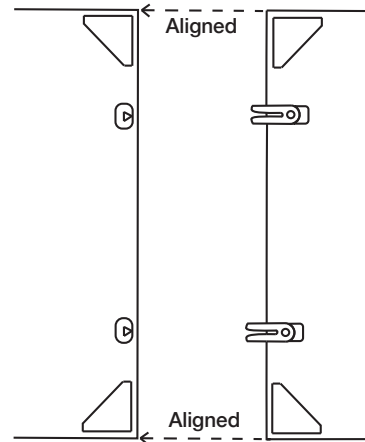

Figure 5. Align units so that front and back are parallel. This is shown by the dotted lines.

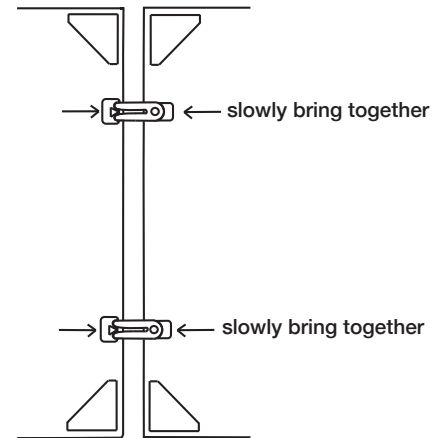

Figure 6. Slowly bring the two units together. Being careful to align Croc-loc Jaws with triangular stump on the opposing unit.

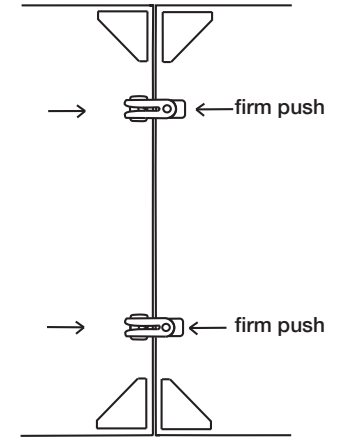

Figure 7. With a firm push as far as possible, close the two units together. (You will hear a ratchet sound as jaws clamp onto triangular stumps.)